



Collection of bollards for commercial and institutional application, the KUBE is an object of urban design that can be integrated into any context and is particularly suitable for paths, parks and landscape areas. Exceptional European build quality with high corrosion resistant finish. Robust marine grade die-cast aluminum construction, with stainless steel fasteners and factory sealed glass diffuser.

Luminaire characteristics:

Power input: 45W
Lumens: 1100lm to 1425 lm (for 3000K, 90CRI)
Luminaire efficacy: Up to 31lm/W

Source:	White LED (LM-80 tested) 2700K: 90CRI, 3000K: 90CRI, 4000K: 90CRI.
Lumen maintenance:	80% of initial lumens at 70 000 hours (L80)(LM-79)
Optics:	Accent light
Material:	Body: Die-cast and extruded aluminum Diffuser: Toughened glass. Hardware: Stainless steel screws and silicone gaskets
Mounting:	Install with flange accessory or fasten to ground
Electrical:	High efficiency electronic LED driver, rated 50 000 hours, 120V-277V
Dimming:	0-10V (120-277V), down to 15%
Finish:	White or aluminum gray painted finish, following a double powder paint in 3 step process: surface treatment containing ceramic nano particles (Bonderite). Epoxy primer paint. Polyester powder paint with high resistance against UV rays and harsh weather conditions.
Weight:	S6340 13.09lbs (5.94 kg) S6346 18.56lbs (8.42 kg) S6347 43.60lbs (19.78 kg)
Warranty:	5 year limited warranty.
Ratings:	IP54, IK06.
Certification:	 cULus listed for wet location

ORDERING INFO

- UNV - - D10

FIXTURE



MODELS

S6340 - Kube 240

S6346 - Kube 580

S6347 - Kube 1350

LED

H - 2700K, 90CRI

W - 3000K, 90CRI

N - 4000K, 90CRI

VOLTAGE

UNV - 120-277V

FINISH

01 - White⁽¹⁾

14 - Aluminum gray

DIMMING

D10 - 0-10V

⁽¹⁾ Available for kube 240 (**S6340**) model

ACCESSORIES

(TO BE ORDERED SEPARATELY)

S3554 - Black Stake (For S6340 only)
H: 16½" (420mm)
(The upper 3½"(90mm) must stay out of the ground)



S5350 - Flange with stainless steel screws
Ø 9¾" x H 9¾"
(238mm x H: 232mm)
(To be installed in concrete)

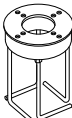

DIMENSIONS

S6340
Kube 240 mm

S6346
Kube 580 mm

S6347
Kube 580 mm

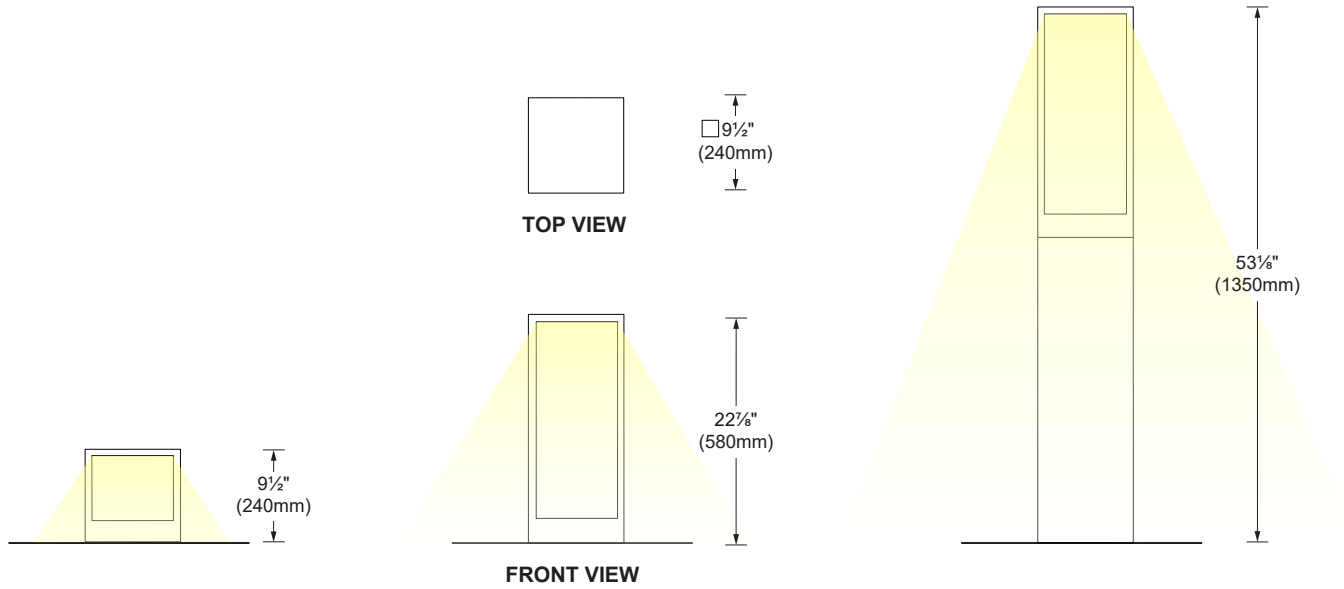

PHOTOMETRIC DATA

Visit sistimalux.com for complete photometric data.

CCT (K)	CRI	LOAD (W)	OPTIC	LUMENS (lm)	EFFICACY (lm / W)	MAX CANDELA (cd)	MODELS
3000K	90	45W	Accent light	1100	24	429	S6340W - 240 mm
				1425	31	764	S6346W - 580 mm
				1425	31	764	S6347W - 1350 mm

Accent light 3000K,90CRI - 240

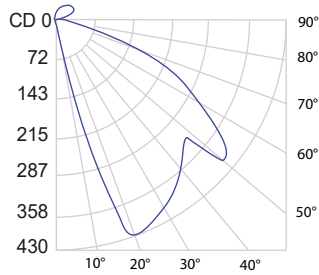

■ -0° H
■ -90° H

Accent light 3000K,90CRI - 580

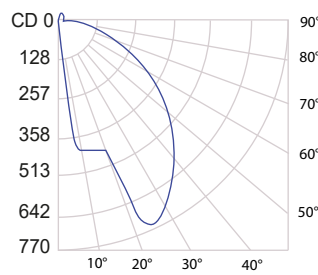

■ -0° H
■ -90° H

Accent light 3000K,90CRI -1350

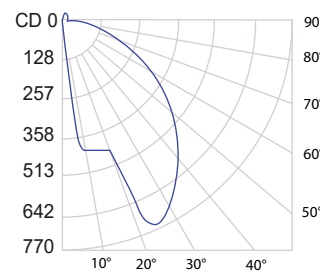

■ -0° H
■ -90° H

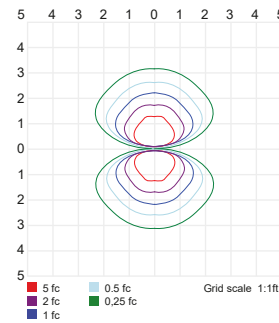
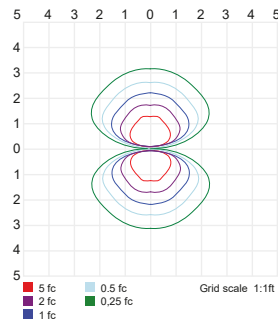
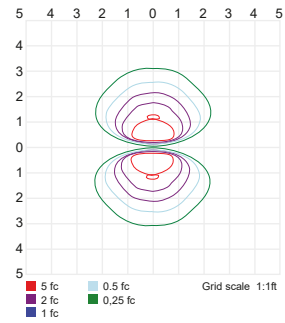

CCT options	2700K	3000K	4000K
CRI options	90CRI	90CRI	90CRI
Multiplier	0.94	1	1.08